



Mounting- and operating instructions

Electronic safety switching device for
limiting the pressure



ES-Series: ES-20 | ES-21 | ES-22

Fluid.iO Sensor + Control GmbH & Co. KG
An der Hartbrücke 6
64625 Bensheim

Tel.: +49-6251-8462-0
Fax: +49-6251-8462-72

Web: www.fluidio.de
E-Mail: info@fluidio.de



Connection 1	Operating voltage
Connection 2	Valve plug
Connection 3	electrical grounding
Connection 4	Process connection

Optional accessories: see scope of delivery

TABLE OF CONTENTS:

1.	SCOPE OF DELIVERY	4	10.3.3.	Min- / Max-Wert	18
2.	GENERAL INFORMATION	4	10.3.4.	Digital I/O	18
2.1.	Installation personnel	4	10.3.5.	Switching and reset point	18
2.2.	Symbols used	4	10.3.6.	Switching delay	18
2.3.	Intended use	4	10.3.7.	Analoger Ausgang	18
2.5.	Safety instructions	5	10.4.	Service	18
3.	TECHNICAL DATA	5	10.4.1.	Diagnostic function	18
3.1.	Norms and directives	6	10.4.2.	Advanced data logging	18
3.2.	Media compatibility	6	10.4.3.	leak test mode	19
3.3.	Extension capability	6	10.4.4.	Error log	19
3.4.	Default settings	6	10.4.5.	Modification management	19
4.	INSTALLATION	7	10.4.6.	Eventlog	19
5.	COMMISSIONING	8	11.	TROUBLESHOOTING	19
5.1.	Connection diagram	8	11.1.	App	19
5.2.	Digital I/O	9	11.2.	ES-2... Device	20
6.	DEVICE FUNCTIONS	10	11.3.	Maintenance and repair	21
7.	FUNCTIONAL DESCRIPTION	10	11.4.	Maintaining, repairing or replacing	21
7.1.	Pressure monitoring	10	12.	FUNCTIONAL SAFETY	21
7.2.	Temperature monitoring	10	12.1.	Project planning	21
7.3.	Pressure switch	10	12.1.1.	Safety function	21
7.4.	Pressure limiter	10	12.1.2.	Safe condition	21
7.5.	Safety pressure limiter	10	12.1.3.	Prerequisites for operation	21
7.6.	Selectable safety function	10	12.2.	Safety-related key figures	22
8.	HANDLING ON THE DEVICE	11	12.3.	Diagnosis and service	23
8.1.	Display and buttons	11	12.4.	Recurring inspection	23
8.2.	Indication on the display	11	13.	SUPPORT	24
8.3.	Open and navigate the menu	12			
8.4.	Unlock-Menu	12			
8.5.	Commissioning menu	12			
8.6.	Configuration menu	13			
9.	OPERATION ON THE SMARTPHONE	15			
9.1.	Connecting the device via Bluetooth ..	15			
9.2.	Entering customer information	16			
9.3.	Documents	16			
9.4.	Language change	16			
10.	APP FUNCTIONS	16			
10.1.	Main Menu	16			
10.2.	Real time parameter display	17			
10.3.	Configuration	17			
10.3.1.	Device base data	17			
10.3.2.	Load/save configuration	18			

1. Scope of Delivery

- Electronic safety switching device ES-2.. incl. wall mounting
- mounting and operating instructions
- Connector 1: 5-pin M12 cable socket
- Connector 2: Rectangular plug

Optional accessories:

- Connector 3: 5-pin M12 cable connector
- Adapter in 4 / 6 / 8 / 12 mm

2. General information

- Read the safety instructions and keep the manual
- Installation, commissioning, electrical connection and repairs may only be carried out by qualified personnel.
- The specified degree of protection is only guaranteed if the unit is installed in the correct position and the cables are inserted and screwed in properly.
- Operate the unit only at the specified voltage
- Modification and conversion of the unit is not permitted and releases FLUID.IO GmbH from any warranty and liability.



Read these mounting instructions carefully before use. Follow the instructions. Keep these installation instructions in a safe place for later use.

2.1. Installation personnel

Installation may only be carried out by qualified personnel.

The electrical connection may only be carried out by qualified electricians. These have electrical training and knowledge of the dangers and effects that can be caused by an electric shock.

2.2. Symbols used



DANGER

Imminently hazardous situation which, if not avoided, will result in serious bodily injury or death.



CAUTION

Possible hazardous situation which could result in minor or moderate bodily injury.



ATTENTION

Possible situation that could lead to property damage to the product or its surroundings.



INFO symbol for important information and tips.

- Enumeration symbol for information on the respective topic.
1. Instruction for action. Carry out the indicated instructions in sequence.

2.3. Intended use

The devices of the ES-2... series are used for protection against exceeding the maximum operating pressure (PSH/PZH/PZHH) or falling below (PSL/PZL/PZLL) the minimum operating pressure according to DGUV regulation 100-500 chapter 2.35 (operator) and EN 378 (manufacturer), for example, in compressors in cooling and air-conditioning systems, refrigeration systems, heat pumps, steam boiler systems (water tube boilers, shell boilers) and general hydraulic systems.

The maximum operating pressure can be found on the type plate on the unit.

Operation is only permissible with:

- **Permanent installation inside buildings.**
- **Installation on a suitable wall.**

2.4. Preventable misapplications

FLUID.IO is not liable for damage caused by use contrary to the intended purpose.

Do not use the device under any of the following circumstances:

- in the near of flammable materials, liquids or gases
- in explosive atmospheres
- outdoors without further protective measures
- when bridging the switching channel
- when pressurised when switched off
- when operating outside the specifications

2.5. Safety instructions

- Installation and electrical connection may only be carried out by qualified personnel.
- Read these operating instructions carefully before commissioning.
- Only operate the unit with the voltage and frequency specified.
- Do not make any changes to the unit.
- Suitable overvoltage protection must be used for power supply lines inside a building that are longer than 30 m or that leave the building..

2.6. Product description

The ES-2... product family is a series of electronic safety switching devices which, depending on the model, can be equipped with various device functions such as

- Pressure switch
- Pressure Limiter
- Safety pressure limiter (type-tested PSH/PSL, PZH/PZL and PZHH/PZLL according to EN 378)

The units are designed as either minimum or maximum limiters and can be configured electronically on the unit or via an app using a smartphone or tablet.

Depending on the model, the units are suitable for use with air and other gaseous media as well as selected aggressive gases and liquids according to the media groups mentioned in the chapter "Media compatibility".

All units of the ES-2... series have a graphic display on which important measurement parameters are shown during operation.

Switching point (SP), reset point (RP) and delay times (dS) can be set easily and highly precisely directly on the display as well as via Android (and iOS) app via Bluetooth.

The ES-2... measures at intervals of 0.1 ms, integrated over a period of 27 ms and compares the measured value with the set switching threshold.

3. Technical data

- Power supply: 16...32 V DC (max. 5.9 W)
- Protection class: IP 65
- Shock- and vibration-proof construction
- SIL 2,
- Dimensions (LxWxH): 158 x 60 x 42 mm (housing without connections)
- Enclosure: anodised aluminium
- Media temperature: -40 °C...+125 °C
- Ambient temperature: -20 °C...+65 °C with relative humidity +5 % ... 90 % at room temperature
- 4...20 mA analogue current output
- Media connection (standard): G 1/4 inch internal thread
- Long-term stable pressure measuring cells for pressure monitoring up to 500 bar
- Nominal pressure ranges: -1...500 bar
Vibration load: Vibration velocity max. 4.5 (10) mm/s (category B class III according to ISO 2372) at 50 Hz

The further technical specifications can be found in the product-specific data sheet on our website www.fluidio.de.

3.1. Norms and directives

The units of the ES-2... series comply with the EMC Directive 2014/30/EU taking into account the following standards:

- EN 55014-1
- EN 55014-2
- EN 61000-6-2
- SIL2
- DIN EN 61508

For an overview of all conforming standards and normative document(s), please refer to the Declaration of Conformity.

3.2. Media compatibility

The units of the ES-2... series are suitable for use with all refrigerants of media groups 1 and 2 according to the Pressure Equipment Directive 2014/68/EU, for example:

- Media group 1: NH3 (R717)
- Media group 2: R22, R134a, R507, R23, R744 (CO2), R404a, R407a, R407c.

Suitable for all refrigerants, including flammable refrigerants, hot water and steam.

Compatibility with other media not mentioned here must be determined separately in consultation with Fluid.iO.

The electronic safety switching device is thus considered to be an equipment part with a safety function within the meaning of the Pressure Equipment Directive Category IV and, in accordance with "VdTÜV Druck 100", a pressure limiter of "special design".

3.3. Extension capability

Depending on the order configuration, the units of the ES-2... series have connector 3 on the ES-2... unit. This is required to connect up to three additional external pressure sensors. This makes it possible to monitor a maximum of four different pressure circuits with different switching limits.

If additional switching channels are required, the order option with ESE device can be selected. This means that there are switching channels on the ES-2... unit and switching channels on the ESE unit to monitor several circuits. In this case, the modules are supplied externally via plug 1 of the ESE unit, connected to plug 1 of ES-2... via plug 3 of ESE, and the pressure sensors are connected to plug 3 of the ES-2... unit. Up to three additional external pressure sensors can be connected via two T-pieces.

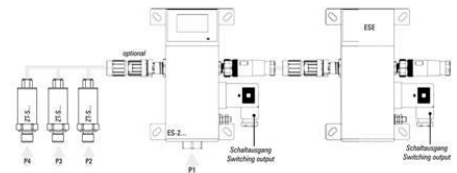

3.4. Default settings

A type label is affixed to each unit in the ES series.

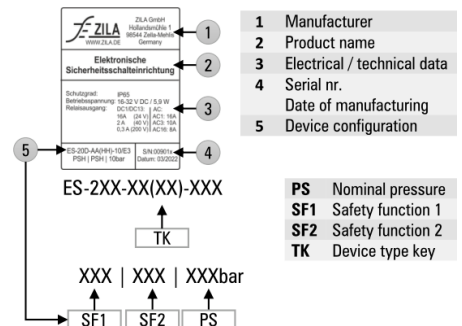

The basic settings of the unit configuration are shown on the type label. The type code can be read off, as well as the safety functions and the nominal pressure PS below it.

The type code is structured in such a way that the type identification (e.g. ES22) is followed by the measured variable (e.g. D for pressure), then the safety function(s), followed by the operating direction(s), the measuring range and finally the extension option(s).

The complete type key of the various type designations can be found in the corresponding data sheets.

The following basic settings and setting ranges are provided as part of the operation of the ES series:

Table Default settings

Parameter	ES-2...
Switching point (SP)	See unit display
Switching delay (dS)	0.2 sec
Analogue output (4..20 mA), S1 Pin4	Current pressure value (4 /20 mA \pm 0 / PS bar)
Alarm output 1 S1 Pin 3	Enabled (SP1)
Alarm output 2 S1 Pin 5	Disabled
Remote unlocking	Disabled
Device self-test	Enabled mit 30 days interval
switching channel self-test	Enabled
Extended data logging	Disabled
Bluetooth	Enabled
Password	Disabled

Table Setting range

Parameter	ES-2...
Switching point (SP)	0..PS in 0,1 % PS steps, it applies PZHH > PZH > PSH, or PZLL < PZL < PSL
Switching delay (dS)	0..1 sec in 0,1 sec Schritte
Analogue output (4..20 mA), S1 Pin4	4 mA \pm 0 .. PS 20 mA \pm 0 .. PS
DIO	Alarm, Fernriegelung, Pegel, deaktiviert
Alarm Direction of action	Steigend, fallend, beide
DIO level	Normal/invertiert

Remote unlocking	S1 Pin 3 bzw. Pin 5 SF1 bzw. SF2 (anstelle von Alarmausgänge)
Self-test device	Aktiviert mit Test alle 30 Tage
Self-test switching channel	Aktiviert
extended data logging	Signaltyp Sample Rate: 1 s..24 h Sample Dauer: 1 min .. 31 d bzw. Enddatum (Ringspeicher)
Bluetooth	De-/aktiviert
Password	De-/aktiviert, ändern 4 stellig numerisch

4. Installation

The ES-2... can be installed in the two positions horizontal and vertical on a suitable surface using the mounting plate.

The mounting plate on the back of the unit already has 4 pre-drilled holes that serve as a fastening.

Fit the earthing cable with a cable lug, connect it to the M6 earthing screw of the enclosure and tighten it with an M6 nut.

Remove any dirt from the surface of the process connection on the unit and then, using a suitable seal, tighten the process connection to a torque of approx. 10 Nm. Finally, connect the appropriate plugs.

Note the cable cross-section:

Ensure that the cable cross-sections are suitable for the load.



CAUTION

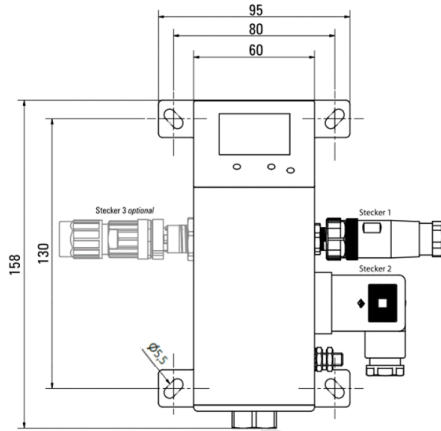

5. Commissioning

The device does not have a separate on/off switch. By applying the specified operating voltage, the unit starts automatically.

All cables and plugs can be connected without opening the device.

During initial commissioning, the safety functions are unlocked.

For your own safety, a password should be assigned and securely noted down during initial commissioning so that no third parties have access to the password.

Avoid damage:

The plug for the operating voltage only fits into the designated socket in a certain position. Make sure that you insert the plug in the correct position, otherwise malfunctions and damage to the unit may occur.



Avoid damage:

Do not apply pressure to the appliance when it is switched off.



5.1. Connection diagram

ES-2...

Connector 1
5-pole M12,
A-coded
Pin assignment
(male)

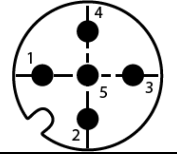

- 1: GND
- 2: 16...32 V DC (max. 5.9 W)
- 3: Digital I/O 1 (configurable)
- 4: Current output (4...20 mA)
- 5: Digital I/O 2 (configurable)

Connector 2
Rectangular
connector
according to EN
175301 form A
**Attention Do not
connect contact 4 to
earth**

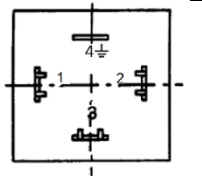

- 1 and 2: Switching channel 1
- 3 and 4: Switching channel 2 (with cable bridge in connector to switching channel 1 for automated switching channel self-test)

If a further stranded wire is installed in a contact of the connector 2 in addition to the cable bridge, the respective stranded wire is to be crimped together with the respective end of the cable bridge in a sleeve.

Connector 3
5-pole M12, A-coded
Pin assignment (female)

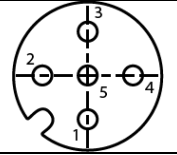

- 1: GND
- 2: Supply for ZT-S...
- 3: Digital I/O (communication to ZT-S...)
- 4: n.c. / not connected
- 5: n.c. / not connected

ESE

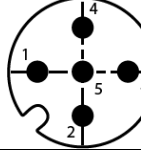
Connector 1 5-pole M12, A-coded Pin assignment (male)	
1: GND 2: 16...32 V DC (max. 5.9 W) 3: Digital I/O e1 (configurable) 4: Current output (4...20 mA) 5: Digital I/O e2 (configurable)	

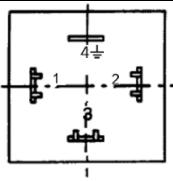
Connector 2 Rectangular connector according to EN 175301 form A Attention Do not connect contact 4 to earth	
1 and 2: Switching channel 3 3 and 4: Switching channel 4 (with cable bridge in the connector to switching channel 3 for automated switching channel self-test)	

If a further stranded wire is installed in a contact of the connector 2 in addition to the cable bridge, the respective stranded wire is to be crimped together with the respective end of the cable bridge in a sleeve.

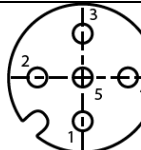
Connector 3 5-pole M12, A-coded Pin assignment (female)	
1: GND 2: Supply for ES-2... 3: Digital I/O (communication to ES-2...) 4: n.c. / not connected 5: n.c. / not connected	

Short-circuit resistance:

- Plug 1:
 - Supply: Permanently short-circuit proof
 - Digital I/O: Permanently short-circuit proof*
 - Current output: Permanently short-circuit-proof*
- Plug 2:
 - switching channels: Permanently short-circuit proof up to 16 A short-circuit current
- Plug 3:
 - Supply: Permanently short-circuit proof*

* only up to max. 2 A short-circuit current

Load capacity of the switching contacts of the relays:
DC operation 24 V:

DC1: non- or weakly inductive loads

($L/R < 1 \text{ ms}$) max. 16,0 A

DC13: Gleichstrommagnete (Schütz) max. 1,5 A

AC operation 230 V:

AC1: nicht o. schwach induktive Lasten

($\cos \phi > 0,95$) max. 16,0 A

AC3: Käfigläufermotoren max. 10,0 A

AC15: elektromagnetische Last (Schütz >72 VA)

max. 7,0 A

5.2. Digital I/O

The devices of the ES-2... series have two independent digital I/O pins that can be configured as inputs or outputs. These can be used, for example, as an alarm or for remote unlocking.

The input level may range from GND to supply voltage (VCC). When configured as an output, a push-pull stage becomes active and can actively drive the output pin to VCC or GND (max. 20 mA).

6. Device functions

Overview of the ES device family with its functional features.

	ES-20	ES-21	ES-22	ESE
Measurand				
Pressure	Yes	Yes	Yes	-
Safety function				
Pressure monitoring	Yes	Yes	Yes	-
Pressure monitor	Yes	Yes	Yes	-
Pressure limiter	Yes	Yes	Yes	-
Safety pressure limiter	Yes	Yes	Yes	-
Selectable safety function:	free	1	2	-
Direction of operation				
Falling / Minimum	Yes	Yes	Yes	-
Rising / Maximum	Yes	Yes	Yes	-
Min/Max combined	Yes	No	Yes	-
Type examination				
Baumustergeprüft nach Druckgeräterichtlinie	Yes	Yes	Yes	Yes
SIL-2	Yes	Yes	Yes	Yes

7. Functional description

7.1. Pressure monitoring

With this configuration, the ES-2... unit is suitable for continuous pressure measurement and display. A switching function to pressure limit values is not provided here.

7.2. Temperature monitoring

With this configuration, the ES-2... device is suitable for continuous temperature measurement and display. A switching function to temperature limit values is not provided here.

7.3. Pressure switch

Type-tested pressure switches according to directive EN 378 are control devices for pressure limitation with two adjustable switching points (switch-on and switch-off point). While the switch-off point is used to limit the system pressure, normal operation is automatically enabled again when the switch-on point is reached.

7.4. Pressure limiter

Type-tested pressure limiters in accordance with directive EN 378 are devices that switch off systems when a set pressure limit value is exceeded or not reached and can then only be reset by manual intervention by authorised persons.

7.5. Safety pressure limiter

A type-tested safety pressure limiter according to directive EN 378 essentially corresponds to a pressure limiter, whereby manual release is only possible by means of an additional tool.

7.6. Selectable safety function

Depending on the unit version, different combinations of functions are available. Depending on the unit version, 1, 2 or more functions can be combined.

7.7. Direction of operation

The operating direction describes whether the switching function is to be triggered when a set switching threshold is exceeded or underrun. Depending on the design of the unit, the following operating directions are available:

- Falling / Minimum
- Rising / Maximum
- Min/Max combined

8. Handling on the device

Device specific menu:

Depending on the configuration of the device, the menu items explained below may not be available in your specific device configuration.



INFO

8.1. Display and buttons

The devices of the ES-2... product family have a graphical display as well as two operating keys and, depending on the design of the device, an additional tool key. The button of the tool key can only be actuated with a tool. If actuation of the tool button is requested on the display, it must be actuated for at least 3 s with a tool.

Button 1 „Arrow down“

This button can be used to navigate through the menu.

Button 2 „Confirm“

This key is used to select menu items and confirm entries.

Tool Button

The tool button is used to unlock the unit in special application scenarios (e.g. safety pressure limiter).

8.2. Indication on the display

The display shows the device status in the top line. The green checkmark indicates that everything is OK. The flashing yellow triangle indicates a switched-off relay and the flashing red triangle indicates a unit error. The spanner is displayed when you are in the Commissioning menu and the cogwheel when you are in the Configuration menu item.

Directly below the first line, the set switching thresholds are displayed on the left and right edge with the direction of action indicated by an arrow. The displayed switching thresholds refer to the displayed pressure value and thus sensor. Each switching threshold is displayed in white as long as it is not exceeded or undercut.

If, in the example of a rising edge, the pressure value is increased above the switching threshold, the safety function is triggered, the relay is switched, the function is locked and the respective switching threshold flashes red in the background. If this safety function is now unlocked when the pressure continues to be exceeded, the respective switching threshold is displayed in red. This symbolises that the pressure is still too high and the relay of the safety function is still inactive. If the pressure is now reduced below the switching threshold, the relay switches on again and displays the respective switching threshold in white.

The currently measured pressure is shown in the centre of the display. The display can be switched by pressing key 1. This displays the temperature as well as the pressure.

When operating an ES-2... device with additional pressure sensors, key 1 can be used to switch the pressure display between the different sensors; pressure and temperature values are displayed in the VIEW. The position of the bar on the bottom bar numbers the sensor from left to right by.

If a running bar is active in the display at the bottom edge of the display, this indicates that the extended data logging is active. If the spanner flashes in addition to the bar, this indicates that the leakage measurement is running in the background. During the tightness measurement, another view can be displayed on the initial screen with key 1. In this tightness view, the respective delta of the current measured values are displayed, related to the values at the start of the tightness measurement.

If several sensors are connected, different views are indicated by greyed-out bars at the bottom of the display. The view of the currently active sensor is shown by the white bar. By pressing the left button you can switch the view of the different sensors back and forth.

At the bottom right, an open lock is still displayed if no password is set or the 60 s timeout after the last password entry has not yet elapsed. No symbol is displayed if password protection is active.

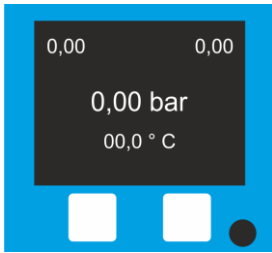

8.3. Open and navigate the menu

The menu can be opened by pressing key 2. Key 1 is used to navigate through the menu items. A menu item is selected by pressing key 2 again.

8.4. Unlock-Menu

This menu can be used to unlock the locked unit functions again. If the security function is greyed out, the function is not locked. However, if the function is shown in white, the function is locked and can be unlocked. To unlock, follow the instructions on the display for the function.

8.4.1. PZH/PZL

To unlock, press the menu item Unlock with the 2 button.

8.4.2. PZHH/PZLL

To unlock, press the menu item Unlock with button 2 and then hold down the tool button for three seconds with a tool.

8.5. Commissioning menu

8.5.1. Information

The "Information" menu area displays various unit information for diagnostic purposes.

Info Test

Displays information about the last self-test.

Info Error

In the event of an error, displays the error code(s) of the unit for service purposes.

Info-Gerät

Zeigt die Gerätebezeichnung sowie die Seriennummer des Gerätes an.

Info-AnalogueOut

Displays the current analogue setpoint and the status of the analogue output.

Info-BT

Displays the MAC address and the device name for Bluetooth connections.

Info-Version

Displays information on the hardware and software version of the unit as well as the production date.

Info-Relais

Indicates the switching status of the relays. "0" means that the relay is open (inactive) and "1" means that the relay is closed (active).

Info-DIO

Shows information about the configuration of the digital inputs and outputs.

Info-PSH/PSL

Displays the set switching value as well as the switching delay and the switching status of PSH/PSL.

Info-PZH/PZL

Displays the set switching value as well as the switching delay and the switching status of PZH/PZL.

Info-PZHH/PZLL

Displays the set switching value as well as the switching delay and the switching state of PZHH/PZLL.

Info-Time

Set date and time of the unit.

8.5.2. Leak test

Executes the leak test feature. The measured values are logged at a set interval on the internal data logger.

When the leak test is started from the ES-2... unit, a measurement takes place every 10 s up to a maximum of 2 hours. The measurement can be stopped prematurely via the unit.

During the leak test, another view can be displayed on the initial screen by pressing key 1. In this density view, the respective delta of the current measured values are displayed, related to the values at the start of the density measurement.

8.5.3. Test Relais

Performs a switching channel self-test on the relays.

Notice:

If a wire jumper has been installed in the plug and this test is carried out, then the connected consumer is not switched off.



For devices of the ES-2... series with a factory-set 30-day interval for the switching channel self-test, it must be ensured that the wire jumper is present in the plug, otherwise the connected consumer will be switched off.

For devices of the ES-2... series without switching channel self-test function, no wire jumper is necessary.

If the test has been carried out successfully, a green symbol lights up permanently on the display.

If the relay can no longer be switched on, a green symbol flashes on the display.

In case of an error, a corresponding symbol is shown on the display together with an error code. Please refer to the information in the error codes section of this manual.

8.5.4. Test PSH/PSL

Performs a test of the switching function PSH/PSL with the associated consequences: Switch off relay, automatic unlocking.

Due to the automatic unlocking function, this unit function must be actively started and stopped by the unit operator.

8.5.5. Test PZH/PZL

Carries out a test of the switching function PZH/PZL with the associated consequences: switch off relay, unlocking necessary.

8.5.6. Test PZHH/PZLL

Carries out a test of the switching function PZHH/PZLL with the associated consequences: Switch off relay, unlocking necessary.

8.5.7. Test Alarm

Performs a test of the alarm function with the associated consequences: Switch DIO.

Due to the automatic unlocking function, this unit function must be actively started and stopped by the unit operator.

8.6. Configuration menu

Most of the parameters for operating the device can be set in the Configuration menu area.

8.6.1. Language

This menu can be used to change the language of the menu navigation during operation. Currently implemented languages: German, English.

8.6.2. PZHH / PZLL, PZH / PZL, PSH / PSL bzw. Alarm

This menu is used to configure the above-mentioned switching points according to the specific unit design. Alarm is displayed when the alarm is selected under DIO.

Switching Point (SP)

Set the switching point at which the above parameters are to be triggered.

Use key 1 to switch between the places before and after the decimal point. With key 2 you can increment the value of the respective digit between 0-9.

When all individual steps have been completed, you can confirm the request to write the values by pressing key 2.

If you press key 1 instead, "Back" appears on the display. By pressing key 2, you can leave this setting menu. Your entry will not be saved.

Pressing key 1 again takes you back to the input of the switching threshold. This allows you to correct your entry.

The switching point can be set from 0 to 115 %. Of course, the switching point of a PZH, for example, cannot be set higher than a PZHH, and a PSH cannot be set higher than a PZH (PZHH > PZH > PSH), corresponding to PZLL < PZL < PSL.

Reset point (RP)

The above switching threshold serves as the automatic reset point for PSH / PSL.

PSH / PSL unlocks automatically:

When the ES-2... device is configured as a pushbutton switch, the PSH or PSL unlocks automatically after the set switching threshold is exceeded or not reached..



Switching Delay (dS)

With the help of the switching delay, you can set the delay with which the triggering of the above-mentioned parameters should take place.

The switching delay can be specified in milliseconds up to a maximum of 1000 ms (1 second).

Use key 1 to switch between the set single digits. With key 2 you can increment the value of the respective digit between 0-9.

When all single steps have been completed, the request to write the values can be confirmed by pressing key 2.

If you press key 1 instead, "Back" appears on the display. By pressing key 2, you can leave this setting menu. Your entry will not be saved.

Pressing key 1 again takes you back to the input of the switching delay.

8.6.3. DIO

The DIO can be configured via this item. The DIO can be set as an alarm with the corresponding direction of action or as a remote release, as well as the level can be switched or the DIO can be deactivated. The corresponding DIO channel is indicated via the index.

Alarm

The alarm allows the selected DIO to be activated when a set switching point is reached, taking into account an adjustable switching delay. To prevent fluttering, a hysteresis has been provided which can be defined via the reset point. First and foremost, the operating direction of the alarm can be set. If no direction of action is set, the other setting options for the alarm are not displayed any further.

Remote unlocking

For the above-mentioned parameters, you can activate or deactivate remote unlocking via the digital I/Os using the selected DIO for the corresponding switching function. Remote unlocking can only be selected for PZH/PZL or PZHH/PZLL.

For the remote unlocking of the safety switching device, it must be ensured that the operating state of the system is recognisable to the operator during the reset.



Level

The level at the DIO output can be switched between normal and inverted. The switching/inversion of the level applies both to the alarm to be output and to the level of the remote unlocking.

Disabled

This menu item can be used to delete the previously set configurations for the DIO. This means that the DIO has no function after it has been deactivated.

8.6.4. Bluetooth

This function allows you to activate or deactivate Bluetooth communication on the device. No further Bluetooth settings are necessary for Bluetooth functionality.

8.6.5. Data logger

The measured values are logged at a set interval. If the data logger is started from the ES-2... device, a measurement takes place every 5 s until the measurement is actively stopped by the device operator.

8.6.6. Factory reset

With this function you can reset the unit to factory settings.

If the factory settings are reset, all safety-relevant parameters must be checked or reset. In addition, the default password 5555 becomes active.



8.6.7. Rotate the display

With this function, depending on the type of device installation, the indication on the display can be rotated by 180°.

8.6.8. Modify Password

To ensure that the device is only operated by authorised personnel, this function can be used to set, change or delete a 4-digit numeric device password ("PIN"). The unit is delivered without a set password and should be set by each user to prevent unauthorised persons from changing the setting.

9. Operation on the smartphone

9.1. Connecting the device via Bluetooth

To connect the ES-2... device to your smartphone via Bluetooth, perform the following steps:

1. Install the app for your smartphone.
2. Activate Bluetooth on your smartphone
3. Activate Bluetooth on your ES-2... device via the menu as described
4. Start the app on your smartphone
5. In the app, press the "Search for devices" button at the bottom of the screen
6. Select your device by pressing the button with the device name

The ES-2... device and the smartphone will then be connected. If the connection is successful, an arrow appears in the app on the right-hand side, with which you can access your ES-2... device.

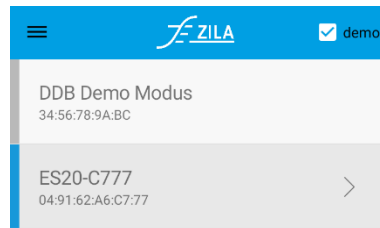

Select the correct device:

The app has a demo mode. We recommend that you do not check the "Demo" box in productive use, otherwise you may connect to the virtual demo device.



Sharing the location data:

In order for Bluetooth devices to be found in your location, you must agree to location sharing.



9.2. Entering customer information

You can enter your user master data via the menu in the top left-hand corner by clicking on the three horizontal lines and selecting **Customer information**.

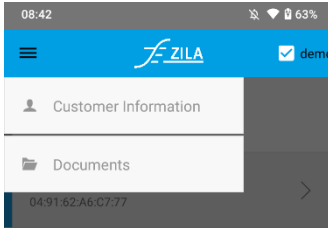
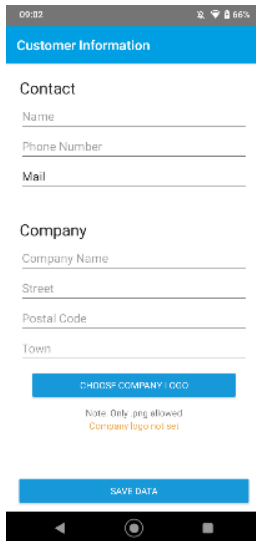
Your own company logo can also be stored here.

<p>By storing the user master data and a logo, documents such as protocols that are created by the app are automatically filled with this data.</p>	 INFO
---	--

Please enter your contact information (" User's master data") in this screen. In a separate menu, you can also enter the test centre where your ES-2... device is used.



9.3. Documents

In this section of the app, you will find web links to various documents such as the manual and declaration of conformity for your unit as well as information on data protection.

Furthermore, you can easily switch to the folder on your smartphone where the stored protocols are located.

Please note the information regarding the device folder in the app.

9.4. Language change

The language displayed in the app depends on the language set on the mobile end device. To change the system language of the app, simply change the system language of your smartphone. After changing the system language, restart the app. To do this, close the app completely.

10. App Functions

10.1. Main Menu

The ES-2... app is divided into four sections:

1. current display
2. configuration
3. service
4. support information

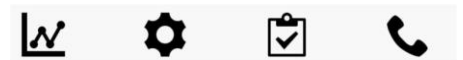

10.2. Real time parameter display

The real-time display shows the measured variables pressure and temperature in a graphical representation (depending on the device).

In addition, you can obtain further information on the device status by clicking on Status.

10.3. Configuration

10.3.1. Device base data

Configure the master data of your ES-2... device here, such as the device name in the Bluetooth menu.

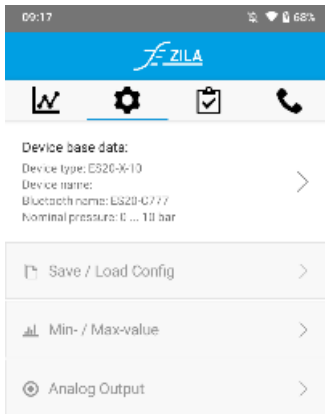

Device Name:

Please note that the device name is limited to 6 characters.



After changing the device name, the device must be reconnected via Bluetooth.



Bluetooth PIN:

With the help of this security function, you can assign a PIN that protects security-relevant functions by means of a PIN query.

As long as no PIN is assigned, there is no security check within the app.

If a PIN is set, you can still connect to the unit without authentication and retrieve various information. Changes to the unit or the unit configuration are not possible.

You can deactivate the PIN function by reassigning the PIN and leaving the input field empty.



Factory reset:

With this function you can reset the device to factory settings.

Please note that by setting the factory settings, all configurations of the device are reset to the delivery status. Therefore, all safety-relevant parameters must be checked or reset.



System time:

Set the desired date and time here.

End customer information:

In this screen, you can store the location where your ES-2... device is in use. This information is automatically included in certain protocols generated by the app.

Use this function to describe your test site.



Adjustment log:

This function generates a PDF document with information about the connected ES-2... unit. It contains information about the manufacturer of the unit as well as the date of manufacture, serial number and set switching thresholds.

In order to open and display the generated PDF, a so-called "PDF Reader" must be installed on the device.	 INFO
---	--

10.3.2. Load/save configuration

Save the current configuration on your smartphone or load an existing configuration onto your ES-2... device.

You can optionally assign a name for the configuration.	 INFO
---	--

10.3.3. Min- / Max-Wert

This function enables the maximum and minimum readings of the unit to be read out and reset.

10.3.4. Digital I/O

The configuration of the digital I/O (DIO) can be done here. An alarm output can be de-/activated via the corresponding DIO. Only when the alarm has been activated here can the switching point be set. In addition, the DIO can be used to set which function can be remotely unlocked.

10.3.5. Switching and reset point

It is possible to set the corresponding switching point or reset point (where available) for each function. Note that, for example, the switching point of a PZH cannot be set higher than that of a PZHH, and a PSH cannot be set higher than a PZH.

10.3.6. Switching delay

Zu jeder Funktion kann die Schaltverzögerung eingestellt werden.

10.3.7. Analoger Ausgang

The measuring signal can be output as an analogue 4...20 mA signal. Within this function, the lower and upper limits of the output signal can be set. So it can be mapped at which pressure 4 mA and at which pressure 20 mA should be output. The currently set values can either be read from the unit or transferred to the unit after configuration.

10.4. Service

10.4.1. Diagnostic function

Within the diagnostic function, the safety function and the digital I/O can be tested just as with the display.

In addition, a protocol can be generated for the switching channel self-test of the relay, showing when the last test was and what the result was.

10.4.2. Advanced data logging

Within the extended data logging function, a measurement series can be started or already recorded measurement series can be displayed.

In the Status area, the data logger is configured and can be started via the button at the bottom of the screen.

In the Data records area, after pressing the button "Retrieve data records", the data records located on the ES-2... are retrieved from the extended data logging.

A detailed view can be opened by clicking on a data record.

Data records can be deleted from the unit by printing and holding on the data record.

The data record can then also be sent by e-mail via the mobile terminal.

To be able to use the e-mail function, an e-mail address must be configured on the smartphone.	 INFO
--	---

10.4.3. leak test mode

In the Status section, the leakage mode function enables a leakage test to be carried out with adjustable parameters such as duration, interval and end time.

In the Data records area, tests that have been carried out can be called up and data records can be deleted by pressing and holding the button.

In the detailed view, further parameters such as pipe volume, test medium and result of the test can be set.

The generated PDF can then be displayed and saved on the smartphone or sent by e-mail.

To be able to use the e-mail function, an e-mail address must be configured on the smartphone.	
--	---

10.4.4. Error log

This function allows you to document any problems with the hardware or software of the unit and send them by e-mail.

For this purpose, various information such as device parameters, an error description generated by the user and optionally a picture of the device are collected. These data, in addition to further error logs, can be sent by email. The error logs can be viewed on a daily basis in the APP. In the error log you can see when which error occurred. The error log also contains a compressed data logging for each error.

The compressed data logging writes an entry per second for the last 60 seconds, then per minute for the last 60 minutes, then per hour for the last 24 hours.

To be able to use the e-mail function, an e-mail address must be configured on the smartphone.	
--	---

10.4.5. Modification management

Represents here which changes have been made in the configuration.

10.4.6. Eventlog

Represents the events that have occurred in the unit. Each event can be sent by email with a compressed data log attached.

11. Troubleshooting

11.1. App

11.1.1. No device in the menu

Error description: After minimising or by pressing the back button several times, no device menu is displayed in the app when the app is opened again or no communication with the device is established.

Solution

Close the app completely and start the app again so that a new Bluetooth connection can be established between the ES-2... unit and the smartphone.

11.1.2. Forgotten PIN

Error description: The set PIN has been forgotten.

Solution

A forgotten PIN cannot be read out. In this case, contact Support.

11.1.3. App works not as expected

Error description: Inputs via the app are not transferred to the device or the connection between app and ES-2... device no longer seems to function properly.

Solution

Various settings on the device via the app can lead to the Bluetooth connection having to be interrupted.

To ensure that the app functions correctly, you should close the app completely in such cases and then restart it.

Alternatively, you can try deactivating Bluetooth on the ES-2... device and then switching it on again. Then reconnect the app to the unit.

11.2. ES-2... Device

11.2.1. Error case

If the error description described in the error code does not make it obvious that the error can be rectified by the relevant specialist personnel, contact the manufacturer and name the error code and send the error report through the app.

11.2.2. Error codes

If there is an error, carry out the described method, if this is not successful, restart the unit and check again whether the error is still present, if so, contact the manufacturer.

Error code	Error description	Solution
00	Supply voltage too low	Check voltage supply
01	Calibration checksum faulty	**
02	Temperature fuse blown	**
03	Relay error Relay 1	**
05	Sensor error 0	**
08	Supply voltage too high	Check voltage supply
09	Configuration checksum faulty	Reset to factory settings
10	Pressure exceeded at sensor (4x) with permanent	**
11	Relay error relay 2	**
13	Sensor error 1	Check sensor cable
16	Ambient temperature too high	Check environmental conditions
17	Programme code checksum faulty	**
19	Relay error relay 3	**
21	Sensor error 2	Check sensor cable
27	Relay error Relay 4	**
29	Sensor error 3	Check sensor cable
33-37	Internal error	**
40	Internal error CPU	**
41	Internal error RAM	**
42	Internal error CFM	**

43	Calibration error	**
44	Configuration error	Reset to factory settings
45-48	Sensor error 4, 5, 6, 7	Check sensor cable
49	Error with ESE communication	ESE-Kabel prüfen
50	Internal error	Restart the device, **

(** = Contact the manufacturer)

11.2.3. Further error scenarios

Error description	Solution
The consumer turns off when the automatic self-test function is carried out.	Check whether there are wire jumpers on connector 2 as described in chapter 5.1.
ES-2... device does not switch on.	Check the pin assignment according to chapter 5.1.
ES-2... does not switch off at expected pressure.	Check whether the switching points have been configured to the correct values..
Pressure loss	Check for leakage at process connection.
Relay does not switch off	Test the ES-2... device manually.
The green check mark flashes, indicating that the relay test is running.	No action required, as it is completed after 5 seconds. However, if it flashes continuously, the relays are switched off and support should be contacted.
In the first line, the complete background flashes yellow..	Keep calm, safety function still present. Contact support.

11.3. Maintenance and repair

The ES-2... device has self-diagnosis functions and is inherently maintenance-free. For further maintenance measures, please refer to the system-specific standards and guidelines.

Danger to life due to missing safety function:

If the safety circuit is taken out of operation, the safety function is no longer guaranteed.

- Do not deactivate the unit.
- Do not bypass the safety function.
- Do not repair, modify or tamper with the unit.



ATTENTION

CAUTION

DANGER

11.4. Maintaining, repairing or replacing

In case of maintenance, repair or replacement of the unit, proceed as follows:

Establish appropriate maintenance schedules for regular maintenance of the safety circuit.

Ensure the correct functioning of the safety circuit while the unit is being serviced, repaired or replaced. If the safety circuit does not work without the unit, shut down the application. Do not restart the application without taking the appropriate precautions. Secure the application against accidental restart.

Do not repair a defective unit. Always have the unit repaired by the manufacturer.

Replace a defective unit only with a unit of the same type.

If used properly, no special maintenance is required during normal operation.

In some applications, dirt build-up on the membrane can influence the measurement result. Therefore, depending on the application, take appropriate precautions to avoid heavy build-up and especially hardening.

When cleaning the sensor, only use cleaning agents and methods that do not attack or damage the housing, type plate and seals (device protection class). External cleaning ensures that the type plate and information on the unit remain visible.

12. Functional safety

12.1. Project planning

12.1.1. Safety function

Each safety switching device has the following safety functions (SF):

- SF1: A variable to be monitored is compared with a threshold value. If the threshold value is violated (exceeded, fallen short of), a relay channel is interrupted.
- SF2: A measured variable is output via a 4-20 mA current output. This analogue signal is fed to a downstream evaluation system.

12.1.2. Safe condition

The safe state for the SF1 is the interruption of the control circuit (open relay channel or switch off consumer). If a malfunction is identified by the internal diagnostic functions, the unit switches to the safe state.

The safe state for SF2, i.e. the current output, depends on the safety function. If a malfunction is detected via the internal diagnostic functions, a signal < 3 mA ("fail low") or a signal > 21 mA ("fail high") is output at the current output.

12.1.3. Prerequisites for operation

- Ensure that the measuring system / safety switching device is used in accordance with the application. The application-specific limits must be observed.
- The specifications according to the operating instructions, in particular the current load of the relay channels, must be kept within the specified limits.
- The instructions in the chapter "Safety-related key figures" must be observed.

12.2. Safety-related key figures

The key figures are determined according to IEC 61508.

The following applies for safety function 1 (switch relay):

Parameter	Value
Safety Integration Level	SIL2 in 2-channel architecture (1oo2)
Hardware Tolerance	Fault HFT 1
Type of device operating mode	Typ A Low demand mode, High demand mode
SFF	99,77 %
MTBF [y]	26
MTTF_d [y]	> 100
diagnostic test interval	

Failure rates

λ_S	λ_{DD}	λ_{DU}	
$2,19 \cdot 10^{-6}$	$2,17 \cdot 10^{-6}$	$\frac{1}{PFH}$	

PFD _{AVG}	$4,35 \cdot 10^{-5}$	(T1 = 1 Jahr)
PFD _{AVG}	$8,73 \cdot 10^{-5}$	(T1 = 2 Jahre)
PFH	$1,00 \cdot 10^{-8}$	

The following applies to safety function 2 (current output):

Parameter	Value
Safety Integration Level	SIL2 in 1-channel architecture
Hardware fault tolerance	HFT 0
Device type	Type A
Operating mode	High demand mode Continuous demand
SFF	99,28 %
MTBF [y]	98
MTTF_d [y]	> 100

Diagnostic interval	test	

Failure rates

λ_S	λ_{DD}	λ_{DU}	
$1,04 \cdot 10^{-6}$	$1,07 \cdot 10^{-7}$	$\frac{1}{PFH}$	

PFD _{AVG}	$3,67 \cdot 10^{-5}$	(T1 = 1 Jahr)
PFD _{AVG}	$7,33 \cdot 10^{-5}$	(T1 = 2 Jahre)
PFH	$8,37 \cdot 10^{-9}$	

Calculation according to EN 61508

Konfig.	PFH [1/h]	PFD (1 Y)	PFD (2 Y)
ES-2...	1,00E-08	4,35E-05	8,73E-05
ES-2... SF1	1,00E-08	4,35E-05	8,73E-05
ES-2... SF2	8,37E-09	3,67E-05	7,33E-05
ESE	7,42E-09	3,22E-05	6,47E-05
ESE SF1	7,42E-09	3,22E-05	6,47E-05
ESE SF2	7,42E-09	3,22E-05	6,47E-05
ZT-S ZDIO	2,58E-09	1,13E-05	2,26E-05
ZT-S AnalogOut	2,58E-09	1,13E-05	2,26E-05
ES-2... SF1 + 3x TZ-S ZDIO	1,77E-08	7,74E-05	1,55E-04
ES-2... ESE SF1/SF2 + 3x TZ-S ZDIO	2,54E-08	1,10E-04	2,21E-04
ES-2... SF1 + ESE SF1/SF2	1,76E-08	7,60E-05	1,53E-04
ES-2... SF1/SF2 + 3x ZT-S ZDIO	1,77E-08	7,74E-05	1,55E-04

The PFD_{AVG} / PFH values depend on the following parameters:

- Parameterisation (two- or single-channel)
- Wiring of the load
- Load (DC, AC, current, voltage, etc.)

Calculation according to EN ISO 13849-1

Modul	DC_{AVG}	$MTTF_d[y]$	CCF	PL
ES-Serie	medium	>100	>65	d

12.3. Diagnosis and service

12.3.1. Behaviour in case of failure

The device is permanently monitored by internal diagnostic routines. If a malfunction is identified, a failure signal is output at the safety-relevant output (see section "Safe condition").

The diagnostic test interval is specified in section "Safety-related key figures".

Depending on the type of error, a corresponding coded error message is indicated in the Info error display menu. The error messages are listed in section "Error codes".

If failures are detected, the entire measuring system must be taken out of operation and the process must be kept in a safe state by other measures.

The occurrence of a failure must be reported to the manufacturer (including a description of the fault and whether it is a dangerous, undetected failure). The device must be returned to the manufacturer for examination.

12.3.2. Repair

The procedure is described in section "maintenance and repair". The notes on parameterisation and commissioning must be observed.

12.4. Recurring inspection

In order to detect possible dangerous, undetected failures, the safety function must be checked at appropriate intervals by means of a repeat test. It is the operator's responsibility to choose the type of check. The intervals depend on the PFD_{AVG} used (see chapter "Safety-related key figures").

If one of the tests is negative, the entire measuring system must be taken out of operation and the process must be kept in a safe condition by other measures.

Test 1: Without checking the process parameter

Conditions:

- Device can remain in the installed state
- Device status on the display: "OK"

Run the "Test Relay" via the commissioning menu on the display. It should be noted that this test is performed internally by itself every 30 days. The result is shown on the display by indicating "OK". In addition, the result with the date of the last test can be read via the info menu "Info test". For logging, the result of the switching channel self-test of the relay can be displayed via the APP on the Service tab and the Diagnostic function entry by clicking on the "Function test" button and a log can be generated of when the last test was and what the result was, which can be sent by email.

Degree of coverage of the test, see section "Safety-related key figures".

Test 2: With verification of the process variable

Conditions:

- Device can remain in the installed state
- Output signal corresponds to the assigned measured variable
- Device status on the display: "OK"

Compare the displayed pressure value of the ES device with the reference pressure measurement.

If the diagnostic status is "OK" and the output signal corresponds to the measured variable, then the output signal corresponds to the reference pressure.

Degree of coverage of the test, see section "Safety-related key figures".

13. Support

Telefon: +49-6251-8462-0

E-Mail: support@fluidio.de

Manufacturer of the device:

Fluid.io Sensor + Control GmbH & Co. KG

Hollandsmühle 1

98544 Zella-Mehlis

Tel.: +49-6251-8462-0

Fax: +49-6251-8462-72

Web: www.fluidio.de

E-Mail: info@fluidio.de